

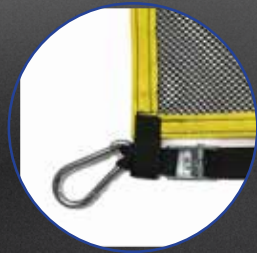

ObeCo[®]

2026 • CATALOG 

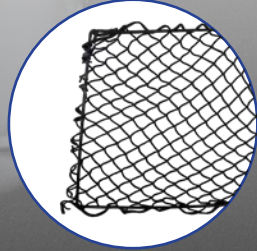
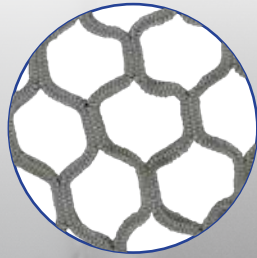

**YOUR CUSTOM
SEWING MANUFACTURER**

DISTRIBUTION

- Tie-down straps
- Rare earth magnets
- Cargo nets
- Organizers | Storage pockets
- Industrial textiles
- Window covers
- Bug screens
- Safety barriers

WE'VE GOT YOU COVERED



1 Custom Industrial Sewing

ObeCo specializes in non-apparel and commercial sewing services.



2 Textiles | Straps | Bungee

Elastic, diamond, and honeycomb netting. PVC materials, mesh, bungee cord, and webbing.



3 Barrier Nets

Barrier and cargo retention netting. Elastic and non-elastic material.



4 Storage Net Pockets

Metal and Polymer framed nets. Choice netting options.



5-9 Fasteners | Hardware

Standard/specialized fasteners and hardware.



10 Custom Strap Assembly

Industrial sewing of webbing, bungee, and other materials utilizing hardware fastening systems.



11-12 Organizers

All purpose organizers for space utilization. Interior and exterior storage options.



13 Clip Nets

Organizational pocket with hidden fasteners designed for plastic and fiberglass molded parts.



14-16 Magnetic Hardware

Interior and exterior magnets.



17-19 Warehouse | Safety

Pallet Rack Netting, Forklift Organizers, Pallet Wraps, Conveyor Safety nets, Semi Trailer Nets.



20 Upholstery Buttons | Caps

Upholstery covered buttons and plastic fastener covers.



21 Sure Seal[®]

Foam gasket material available in rolls and custom die cuts.



22-23 Other Cool Products

Clothes hooks, shower shelves, EZ battery chargers, Bottle openers, SkyeDen™ Rooftop Tent.

Quality Custom Industrial Sewing

ObeCo specializes in non-apparel industrial sewing services and commercial sewing

Services

- Single/Multi needle sewing equipment
 - *Straight and box stitching various materials using high quality thread.*
- State-of-the-art heat welders
- CNC textile cutting
 - *ObeCo utilizes a reliable and highly productive state-of-the-art conveyerised cutting system ensuring your product is manufactured on time.*



Textiles | Straps | Bungee

ObeCo carries a variety of materials both elastic and non-elastic for manufacturing a infinite number of products including strap components.



Black Diamond	
Material	Nylon Net
Details	Available Sizes: 12" • 18" • 24" • 32" (Non-elastic)
Hole Size	1"

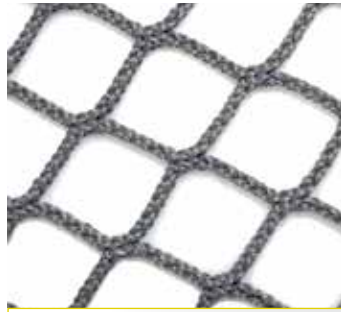

Gray Diamond	
Material	Nylon Net
Details	Available Sizes: 12" (Non-elastic)
Hole Size	1"



Tan Diamond	
Material	Nylon Net
Details	Available Sizes: 12" (Non-elastic)
Hole Size	1"

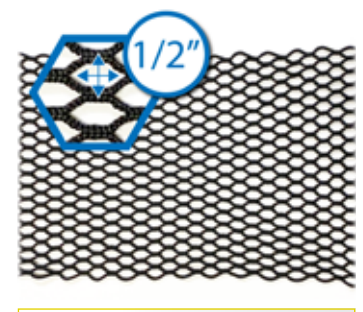

8" Honeycomb	
Material	Nylon Net
Details	Ideal for storing smaller items or as a cargo restraint. (Non-elastic)
Color	Black

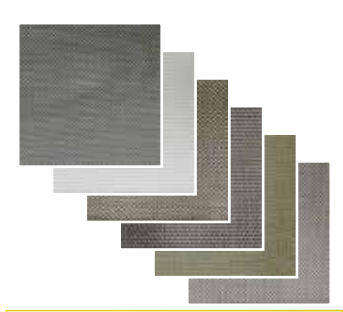

54" Textilene	
Material	Textilene Mesh
Color	Titanium/Pearl/Brass/Black/ Beige/Aluminum



48" Plastic Coated Mesh	
Material	All Purpose Mesh Screen
Details	11" x 11" plain weave nylon coated fiberglass open mesh fabric.
Fabric Weight	10 oz. per Sq. Yd.
Color	Black



60" Economy Mesh	
Material	PV81
Details	100% Black Solution Dyed Polyester
Fabric Weight	10 oz. per Sq. Yd.
Color	Black

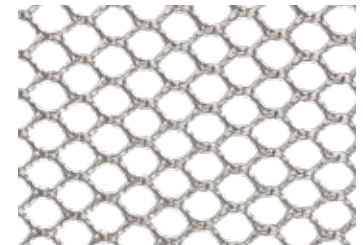

60" Polyester Hex	
Material	Polyester hex mesh screen net
Details	Projects that require a high degree of strength and durability. 5.9 oz. raschel construction. 9 holes per sq. in. (Non-elastic)
Color	Black/White/Gray

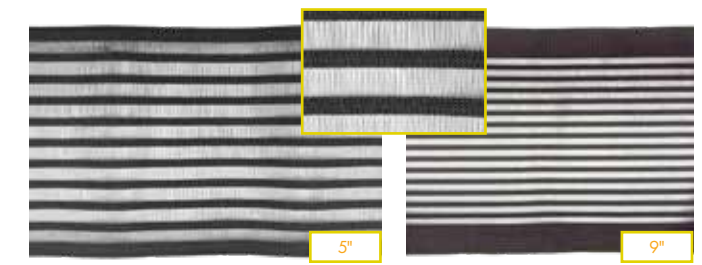

5" • 9" Kiiper® Net	
Material	Stretch net with sewn edge
Sizes	5" • 9"
Colors	Black

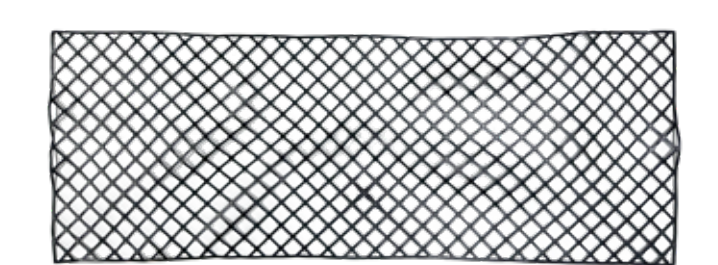

12" x 32" Urethane Diamond Net	
Material	Urethane
Sizes	12" • 32"
Color	Black

Barrier Stretch Nets | Coverings

Stretch net is a great option for a variety of applications. UV resistant and fire retardant bulk netting is sold by the running foot and available in different colors and widths.

Available Stretch Net Heights



Available Net Material | Colors available 8" only

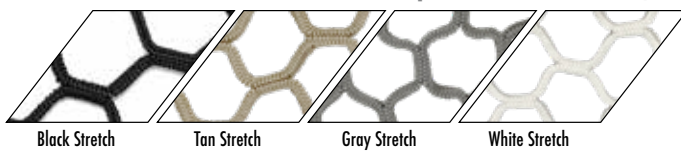

3/16" and 1/4" Bungee Cord | 4 Colors

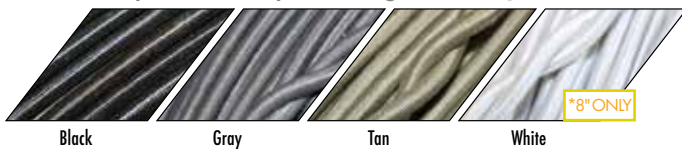

1/4" Polyurethane Elastic Cord

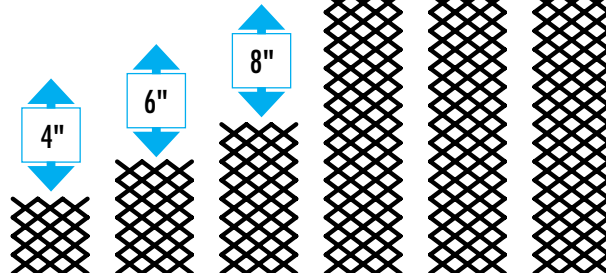

Barrier Stretch Net

15" and 32" • Loop Stretch Net

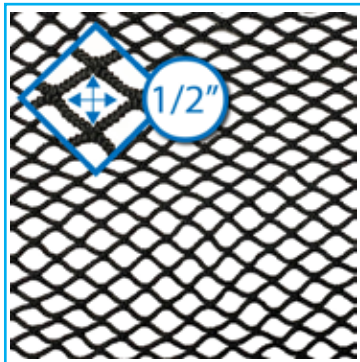

Loop stretch net has an elastic edge manufactured into the top and bottom for a premium modern look.

Available in Black Only



Storage Net Pockets

ObeCo storage pockets are available in a variety of sizes, colors, materials, and pocket configurations that have an infinite number of applications to fit your needs. These rugged and durable products are manufactured to the highest standards to fulfill your needs.

Plastic Frame



4 1/4" x 9"	
Part	TWP-49SFRAME
Frame	Polyacetal Plastic/ Reinforced stainless steel wire core
Color	Black
Net Material	Elastic Net
Mounting Hardware	4 - #4 Screws

8" x 11 3/4"	
Part	TWP-811SFRAME
Frame	Polyacetal Plastic/ Reinforced stainless steel wire core
Color	Black
Net Material	Elastic Net
Mounting Hardware	4 - #4 Screws

8" x 16"	
Part	TWP-816SFRAME
Frame	Polyacetal Plastic/ Reinforced stainless steel wire core
Color	Black
Net Material	Elastic Net
Mounting Hardware	7 - #4 Screws

8" x 32"	
Part	TWP-832SFRAME
Frame	Polyacetal Plastic/ Reinforced stainless steel wire core
Color	Black
Net Material	Elastic Net
Mounting Hardware	9 - #4 Screws

4 stock sizes available. 5000 pc. minimum order for custom sizes.

Steel Wire Frame

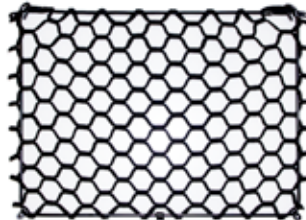
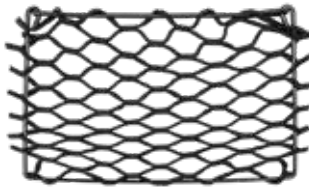

8" x 12"	
Frame	Powder Coated Steel Wire
Color	Black
Material	Netting
Mounting Hardware	P-Clamps

12" x 16"	
Frame	Powder Coated Steel Wire
Color	Black
Material	Netting
Mounting Hardware	P-Clamps

12" x 31"	
Frame	Powder Coated Steel Wire
Color	Black
Material	Netting
Mounting Hardware	P-Clamps

12" x 48"	
Frame	Powder Coated Steel Wire
Color	Black
Material	Netting
Mounting Hardware	P-Clamps

Available Net Material | Colors

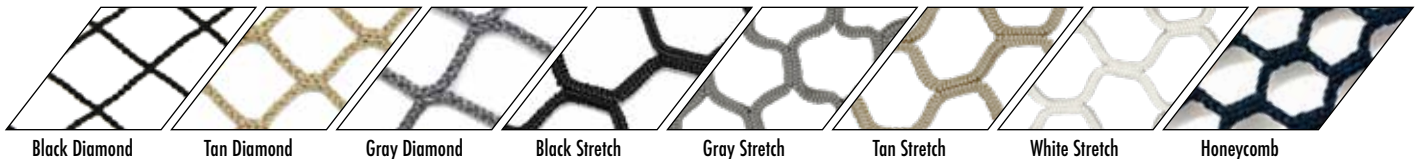

Custom netting and metal frame sizes available. 100 pc. minimum order.

Fasteners | Hardware

We offer a unique line of fasteners and fastening systems. These hard to find parts are useful in RV's, boats, cargo trailers, homes, and more.



J-Hooks	
Part #	RT-JHOOK-(Color)
Size	3/4" •Wide (20mm) 1 1/8" •Wide (27mm) 3/4" •Tall (20mm)
Colors	Black/Gray/Tan/White
Material	Nylon/UV resistant

Attachment Knobs	
Part #	SP87 SP86
Size	1 1/16" •Dia. (8mm) 9/16" •Tall 5/8" (13mm)
Colors	Black/White
Material	Nylon/UV resistant

Lash Hooks	
Part #	LashHook-BLK
Size	1/2" •Wide (10mm) 1 1/8" •Long (38mm) 5/8" •Tall (17mm)
Colors	Black
Material	Nylon/UV resistant

Shock Cord Hooks	
Part #	SP1450B, SP1400W
Size	1 5/16" •Wide (34mm) Screw to screw edge/ 1" •Point to screw edge (25mm) 5/8" •Tall (17mm)
Colors	Black/White
Material	Nylon/UV resistant

Tent Wall Hooks	
Part #	SP55B, SP50W
Size	1 7/8" •Long (47mm) 7/8" •Wide (22mm) 3/4" •Tall (20mm)
Colors	Black/White
Material	Nylon/UV resistant



Pocket Door Holder	
Part #	OB-UPDH-3 OB-UPDH-4 OB-UPDH-5
Size	4" •5" •6"
Available Colors	Black
Material	Polycetal Plastic Nylon/UV resistant/ Bungee cord

Custom Bungee Loops	
Size	Custom Length
Available Colors	Black
Material	Polycetal Plastic Nylon/UV resistant/ Bungee cord

Shock Cord Clips	
Part #	SP70W SP75B SP75-8B, SP75-14B
Size	3 1/2" •4" •6"
Available Colors	Black/White
Material	Polycetal Plastic Nylon/UV resistant/ Bungee cord

Pull Tabs	
Part #	CL-680-3B(Color)
Size	2 3/4" •Length (67mm) 7/16" •Width (13mm)
Available Colors	Black/White
Material	Nylon Rope/Plastic tab/UV resistant

P-Clamps	
Part #	LPC-3 WIRE CLAMP LPC-4 WIRE CLAMP
Size	3/16" • 1/4"
Available Colors	Black
Material	Nylon



1" • Footman Loop	
Part #	EYESTRAPBLK
Size	1 5/8" •Long (40mm) 1/2" •Wide (11mm) 5/8" •Tall (15mm) 3/8" •Opening (10mm)
Available Colors	Black
Material	Black powder coated steel

Plastic Eyelet	
Part #	EyeletPLBLK
Size	1 7/8" •Long 1/2" •Wide 9/16" •Tall 3/8" •Opening
Colors	Black
Material	Polyacetal Plastic /UV resistant

1" • Footman Loop	
Part #	FTMNLOOP-1-BEC FTMNLOOP-1
Size	2 1/2" •Long (63mm) 3/8" •Wide (10mm) 1/2" •Height (13mm) 1" •Opening (25mm)
Available Colors	Black Brass/Nickel
Material	Black powder coated steel/Steel

1 1/2" • Footman Loop	
Part #	FTMNLP-1.5
Size	FTMNLP-1.5
Available Colors	Brass/Nickel
Material	Nickel/Zinc

2" • Footman Loop	
Part #	FTMNLP-2
Size	3" •Long (76mm) 1/2" •Wide (10mm) 3" •Long (76mm) 5/8" •Tall (17mm)
Colors	Brass/Nickel
Material	Nickel/Zinc



WE'VE GOT YOU COVERED



Bungee Cord Hook/ With Tongue	
Part #	HOOK-WT
Size	1 3/4" • Length (44mm) 5/8" • Wide (18mm) 1/2" • Thick (12mm)
Colors	Black
Material	Polyacetal Plastic /UV resistant



Bungee Cord Hook/ No Tongue	
Part #	HOOK-WOT
Size	1 3/4" • Length (44mm) 5/8" • Wide (18mm) 1/2" • Thick (12mm)
Colors	Black
Material	Polyacetal Plastic /UV resistant



Bungee Cord Terminal End	
Part #	RSB4
Size	1 1/2" • Length (32mm) 3/8" • Wide (10mm) 1/2" • Thick (12mm)
Colors	Black
Material	Polyacetal Plastic /UV resistant



2 pc. Bungee/Elastic Loop & Coupler Connector	
Part #	TC4
Desc.	3/16" & 1/4" • Bungee
Size	3/8" • Wide (9mm)
Colors	Black
Material	Polyacetal Plastic /UV resistant



Dome Hook Horizontal	
Part #	SP92B
Desc.	Low profile dome hook
Size	2 1/4" • Wide (57mm)
Colors	Black
Material	Polyacetal Plastic /UV resistant



1" • Sewable Ladder Lock	
Part #	LL 407-25
Size	1 1/2" • Wide (10mm) 1 1/8" • Long (38mm) 5/8" • Tall (17mm) 3/16" • Hole (5.5mm)
Colors	Amber/Black
Material	Carbon steel/ Yellow zinc



2" • Ladder Lock	
Part #	LL517-51
Size	1"
Colors	Black
Material	Nylon/UV resistant



2" • Chafe Tab	
Part #	LP424-51
Size	2" • Wide (10mm) 1 1/8" • Long (38mm) 1/8" • Tall (17mm)
Colors	Black/Nickel
Material	Nylon/Steel/Nickel



3" • Carabiner	
Part #	CARCLP3SZ
Size	3 1/2" x 1 3/4"
Colors	Brass/Nickel
Material	Steel Nickel



3" • Carabiner	
Part #	HOOK245M-60BK
Size	1 5/8" • Wide (42mm) 3 1/4" • Long (80mm) 3/8" • Tall (10mm)
Colors	Black powder coated
Material	Steel Nickel



2" • Heavy Duty Hook	
Part #	HOOK 2" TWISTED
Size	3 1/4" • Long (83mm) 1 1/2" • Wide (38mm) 1/2" • Thick (12mm)
Colors	Amber
Material	Carbon steel/ yellow zinc



1" • Swivel Snap Hook	
Part #	HOOK-SWIVSNAP
Colors	Brass/Nickel
Material	Steel/Nickel plated



1" • Snap Hook	
Part #	HOOK-1SSNAP
Size	1 1/4" • Wide (32mm) 2" • Long (50mm) 1/2" • Tall (12mm) Hole: 1" • Wide (25mm)
Colors	Brass/Nickel
Material	Steel/Nickel plated



1" • Swivel Snap Hook	
Part #	SH331TC-25-BW
Size	1 1/2" • Wide (38mm) 2 1/2" • Long (27mm) 5/8" • Thick (15mm)
Colors	Black/White
Material	Polyacetal Plastic/ UV resistant



Bungee Cord Hook	
Part #	SIQCN316
Size	2 1/2" • Long (50mm) 3" • Tall (12mm) Hook: 1" • Wide (25mm) Thick: 1/4"
Colors	Black
Material	Nylon/UV resistant



ObeCo Inc.
manufactures the
most durable Bunk
Bed Safety Nets on
the market



3/4" • Clip and D-Ring	
Part #	CLIPDEE-3/4
Size	13/16" • Wide (26mm) 1 1/2" • Long (38mm) Tab: 5/8" • Wide (16mm) Hole: 3/16" (5mm)
Colors	Brass/Nickel
Material	Steel Nickel

Single/Vertical Grommet Attachment	
Part #	SP34B, SP34W
Size	1 3/8" • Long (47mm) 5/8" • Wide (17mm) 5/8" • Tall (17mm)
Colors	Black/White
Material	Fiberglass/Nylon

Double /Vertical Grommet Attachment	
Part #	SP35B, SP35W
Size	1 3/8" • Long (47mm) 5/8" • Wide (17mm) 3/4" • Tall (17mm)
Colors	Black/White
Material	Fiberglass/Nylon

Single/Horizontal Grommet Attachment	
Part #	SP37B, SP37W
Size	1 3/8" • Long (47mm) 5/8" • Wide (17mm) 5/8" • Tall (17mm)
Colors	Black/White
Material	Fiberglass/Nylon

Double/Horizontal Grommet Attachment	
Part #	SP38B, SP38W
Size	1 3/8" • Long (47mm) 5/8" • Wide (17mm) 3/4" • Tall (17mm)
Colors	Black/White
Material	Fiberglass/Nylon



SNAD® SELF ADHESIVE SNAP STUDS	
Part #	SNAD-25STUD-B SNAD-25STUD-W SNAD-25STUDF-C SNAD-40STUD-B SNAD-40STUD-W SNAD-40STUDF-C
Size	25mm-Rigid 25mm-Flexible/Clear 40mm-Rigid 40mm-Flexible/Clear
Colors	Black/White/Clear
Material	Nylon/UV resistant

Locking Snap Fastener	
Part #	9320-N
Desc.	These metal spring clip fasteners have a spring element inside the center that can be pulled to achieve fastening and detachment.
Colors	Silver
Material	Nickel/Zinc Plated

10" Velcro Strap	
Part #	LPC10VEL
Size	11.13" Long (282.6mm) 1" Wide (25.4mm)
Colors	Black
Material	Nylon

Hook Adhesive Back	
Desc.	Rubber/Acrylic Base available
Size	50 yd. Spools 5/8" - 4"
Colors	Black/White
Material	Nylon

Loop Adhesive Back	
Desc.	Rubber/Acrylic Base available
Size	50 yd. Spools 5/8" - 4"
Colors	Black/White
Material	Nylon



Hook • Sewable	
Desc.	Sewable
Size	50 yd. Spools Multiple sizes available
Size	50 yd. Spools 5/8" - 4"
Colors	Black/White
Material	Nylon

Loop • Sewable	
Desc.	Sewable
Size	50 yd. Spools Multiple sizes available
Size	50 yd. Spools 5/8" - 4"
Colors	Black/White
Material	Nylon

Bungee Cord Clips	
Part #	68S-032-0-ST 68S-032-0-BR
Desc.	For 3/16" • Bungee
Size	3/8" • Wide (9mm)
Colors	Black/Brass
Material	Brass/Steel

We're always thinking up new products you've never thought of...



Have ideas? We'll build it for you



Panel Fasteners

Description	Panel fasteners are used for attaching material of various composition and thickness. These are found in electronic products, furniture, automotive door panels, seating and trim.
Colors	Black/White Nylon



E Track Clip

Part #	E-CLIP
Size	2 3/4" Long 1/8" Wide 1/2" Tall
Colors	Amber
Material	Carbon steel/ Yellow zinc



1" Heavy Duty Hook

Part #	06-CC EF8062
Size	1 3/4" Long (45mm) 1 5/8" Wide (29mm) 5/8" Thick (17mm) 1760 lb Break strength
Colors	Amber
Material	Carbon steel/ Yellow zinc



F-Hook

Part #	#F-Hook
Size	2 1/2" Long (63mm) 2 1/2" Wide (64mm) 1 5/16" Thick (36mm) 800 lb Break strength
Colors	Amber
Material	Carbon steel/ Yellow zinc



2" Double J Wire Hook

Part #	06-CC EF8005-20
Size	3 5/16" Long (87mm) 2 11/16" Wide (68mm) 1 5/8" Thick (40mm) 4400 lb Break strength
Colors	Amber
Material	Carbon steel/ Yellow zinc



1" Double J Wire Hook

Part #	06-CC EF8019
Size	1 7/8" Long (46mm) 1 1/2" Wide (40mm) 1" Thick (26mm) 1700 lb Break strength
Colors	Amber
Material	Carbon steel/ Yellow zinc



Vinyl Coated S-Hook Hook

Part #	06-CC EF8048
Size	4 7/16" Long (12mm) 3/4" Wide (45mm) 7/16" Thick (10mm) 3300 lb Break strength
Colors	Black
Material	Carbon steel



1" Ratchet

Part #	06-CC RB8021-10ZB
Size	4 1/4" Closed (108mm) 6" Open (152mm) 1 7/8" Wide (47mm) 5/8" Tall (17mm) 2200 lb Break strength
Colors	Amber/Black
Material	Carbon steel/ Yellow zinc



1" Ratchet

Part #	06-CC RB8040-08SH
Size	4 3/8" Closed (113mm) 5 1/5" Open (140mm) 1 7/8" Wide (47mm) 1 1/2" Tall (40mm) 1760 lb Break strength
Colors	Black/Amber
Material	Carbon steel/ Yellow zinc/Rubber



2" Ratchet

Part #	06-CC RB8003
Size	4 1/4" Closed (108mm) 5 1/5" Open (152mm) 1 7/8" Wide (45mm) 5/8" Tall (17mm) 2200 lb Break strength
Colors	Amber
Material	Carbon steel/ Yellow zinc



1" Cam Buckle

Part #	06-CC CB8017-500
Size	1 7/8" Long (50mm) 1 3/8" Wide (35mm) 13/16" Tall (21mm)
Colors	Nickel
Material	Steel Nickel



1" Cam Buckle

Part #	CAM1STLBR300
Size	1 1/2" Long (39mm) 13/16" Wide (31mm) 5/8" Tall (15mm)
Colors	Black powder coated
Material	Steel Nickel



2" Cam Buckle

Part #	06-CC CB8003
Size	2 7/8" Long (73mm) 2 5/8" Wide (66mm) 1 1/4" Tall (30mm)
Colors	Nickel
Material	Steel Nickel





2" • Seat Belt Buckle

Part #	SEATBKL SC206A3
Size	4 3/4" • Long (120mm) 1 1/8" • Wide (60mm) 1 1/4" • Thick (30mm)
Colors	Black/Red/Nickel
Material	Nylon/UV resistant

Gripper Clips

Part #	225 P • 7/32" - 1/2" 225 S • 3/8" - 5/8" 225 L • 3/4" - 1 1/8" 225XL • 1" - 1 3/8"
Colors	Nickel
Material	Nickel plated/Spring steel

Gripper Clips • Half Vinyl Coated

Part #	225 HL • 3/4" - 1 1/8" 225 HXL • 1" - 1 1/2"
Colors	Black/Nickel
Material	Nickel plated/Spring steel/Vinyl coated

Gripper Clips • Full Vinyl Coated

Part #	225 FS • 3/8" - 5/8" 225 FL • 3/4" - 1 1/8" 225 FXL • 1" - 1 1/2" 250 N • 2" - 2 1/2"
Colors	Black
Material	Nickel plated/Spring steel/Vinyl coated

Gripper Clips • Flash Light

Part #	250 K • 1 1/2" - 1 7/8"
Colors	Black
Material	Nickel plated/Spring steel/Vinyl coated



Radius Blocks

Part #	RB212SX1 RB3200X1 RB4000X1 RB212S RB2620 RB3200x1-1 RB4000x1-1 RB212Sx1-2
Colors	Black/Tan/Gray
Material	Nylon/UV resistant

Air Vent Cover

Part #	CVO 6000 B CVO 6000 S CVO 6000 G
Desc.	Exterior 6" clam shell cover
Colors	Black/White/Gray
Material	Nylon

3" • Air Vent Cover

Part #	CVI6000B CVI6000W CVI6000G
Desc.	Interior 3" vent cover
Colors	Black/White/Gray
Material	Nylon

4" • Air Vent Cover

Part #	MV4000B MV4000W MV4000G
Desc.	4" vent cover
Colors	Black/White/Gray
Material	Nylon

Vent Cap

Part #	VC100B VC100W
Desc.	1 1/2"- 2" Waste vent cap
Colors	Black/White
Material	Nylon



4" Bumper End Cap

Part #	BEC4
Colors	Black
Material	Polyethylene

Wire Pull Grommets

Part #	GR1100B GR1100N
Colors	Black/Natural
Material	Nylon

Ramp Door Bumper

Part #	RDB1000
Desc.	2/5" round rubber bumper
Colors	Black
Material	Rubber

Door Stop

Part #	RV3003(Color)
Colors	Black/White/Colonial White/Gray
Material	Nylon

Door Stop

Part #	RV3004(Color)
Colors	Black/White/Colonial White/Gray
Material	Nylon

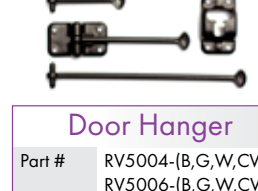

Flat License Plate Holder

Part #	LPH100
Colors	Black/White/Gray
Material	Nylon/UV resistant

Step License Plate Holder

Part #	LPH200
Colors	Black/White/Gray
Material	Nylon/UV resistant

Full License Plate Holder

Part #	LPH300
Colors	Black/White/Gray
Material	Nylon/UV resistant

95/8" • Grab Handles

Part #	GH1000 (Color)
Size	95/8" • Long 1/8" • Wide 1/2" • Tall
Colors	Black/White/Gray
Material	Nylon

Door Hanger

Part #	RV5004-(B,G,W,CW) RV5006-(B,G,W,CW) RV5008-(B,G,W,CW) RV50010-(B,G,W,CW) RV50012-(B,G,W,CW) RV5090-(B,G,W,CW)
Desc.	3 pc. set include; arm lengths, male base, and female base
Colors	Black/Gray/ White/ Colonial white
Material	Nylon

Straps | Bungee Assembly

When it comes to cargo control supplies you can trust, look to ObeCo for your manufacturing needs. We manufacture and distribute professional grade cargo control products including tie-downs, load binders, winch straps, e-track, ratchet straps, and more. No matter what industry you're in, ObeCo has the inventory to protect your precious cargo.

Strap Services

- Box "X" Stitching
- Straight Stitching
- Heat Welding
- Hole Punching
- Grommet/Rivet Setting
- Various Connectors
- Bungee Services • 3/16"- 1/4"

Available Hardware

- Ratchets
- Cam Buckles
- Tactical Buckles
- Webbing Slide Buckle
- Welded O-Ring
- S-Hook
- Flat Hook
- Double Hook
- O-Ring
- D-Rings
- Double D-Ring
- Screw Mounted D-Ring
- E-Track Clip
- Carabiners
- Rectangular Loops
- Slides
- Snap Hooks
- Grommets
- Eyelets
- Rivets



Quality Custom Industrial Sewing

ObeCo specializes in non-apparel industrial sewing services and commercial sewing

Manufacturing

- Barrier netting
- Organizers/Storage pockets
- Tie-down straps
- Window covers
- Bug screens
- Inventory catchers
- Safety barriers

Applications

- Recreational vehicles
- Marine
- Toy haulers
- Emergency vehicles
- Utility trucks
- Port-a-Johns
- Warehouses
- Forklifts
- Shipping containers
- Semi-trailers
- Ice Houses
- and more



Get Wet Organizers

Get Wet Organizers are made with Textilene: A mold and mildew resistant material for wet interior and exterior environments.



10" x 12"

Pockets	1
Material	Textilene
Mounting Hardware	Screw studs or SNAD® fasteners

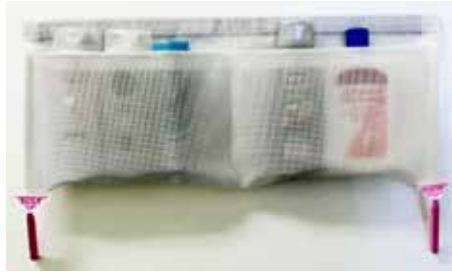

10" x 24"

Pockets	2
Material	Textilene
Mounting Hardware	Screw studs or SNAD® fasteners



36" x 12"

Pockets	3
Material	Textilene
Mounting Hardware	Screw studs or SNAD® fasteners

Available Textilene Material

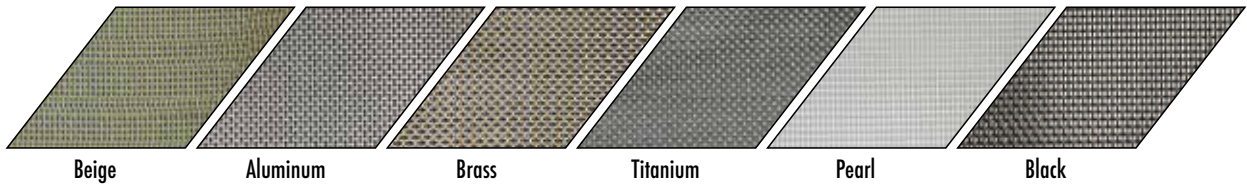

Custom sizes available. 25 pc. minimum order.

All purpose organizers

Stretch Net

Stretch Net Pockets are ideal for many organizational needs. Use Stretch Net Pockets to store items in your home, garage, RV, boat, or cargo trailer. Made with versatile stretch netting and heavy duty canvas. Stainless steel cap and sockets for semi-permanent attaching, ensuring zero corrosion.



Gear Net

Gear Nets make organizing a breeze. Mount the Gear Net on any open wall space for immediate heavy duty storage. Use Gear Nets in your garage, RV, boat, or cargo trailer to organize items.



Clip Nets

Clip nets achieve the finished automotive look by using proprietary crimping tools. Brass clips, crimped on the ends of our nets, are installed into molded plastic or fiberglass components. This creates a clean, premium upscale look. We work with a variety of custom molders to meet the needs of our customers. Clipped nets are available in stretch and diamond netting.

Stretch Net

- Black
- Gray
- White
- Tan



Diamond Net

- Black
- Gray
- Tan

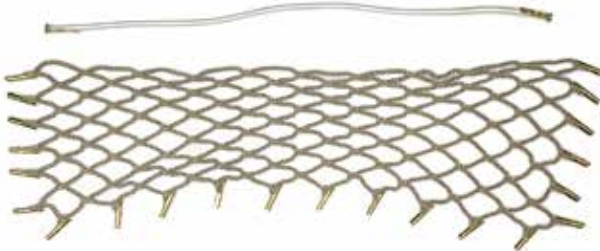

Magnets

ObeCo carries a variety of magnet hardware. Our unique product line is ideal for RV and marine applications. Everything from cabinet doors, interior/exterior storage compartment doors and drawers, etc.



Baggage Door Magnet • 10lb

Part #	DM-BAGGAGEMAG-1 DM-BAGGAGEMAG-WHT
Material	1 pc block neodymium magnet in 1 pc. plastic case/1 pc. strike plate
Magnetic Grade	N42
Magnet Size	32x8x15.88mm
Magnet Coating	Zinc
Strike Plate Coating	Black/White powder coated
Color	Black/White
Orientation	Through 15.88mm H
Magnetic Force	Up to 10 lb.



Rectangle Magnet Set • 4lb

Part #	DM-BAGMAG-RECT-1
Material	1 pc block neodymium magnet in 1 pc. plastic case/1 pair set. North/South
Magnetic Grade	N52
Magnet Size	13x9x10mm
Magnet Coating	Zinc
Plastic Case Size	38.1-L x 17-W x 14-H
Color	Black
Orientation	Through 10mm H
Magnetic Force	Up to 4 lb.

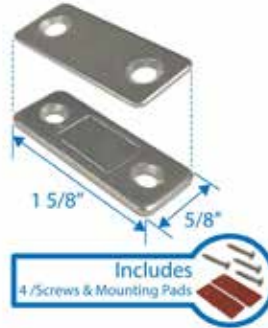

Flat Door Magnet • 10lb

Part #	DM-FM-10
Material	1 pc block neodymium magnet/1 pc. steel case/1 pc. strike plate/4 pc. screws/2 pc. adhesive tape
Magnet Size	41.5x17x2.3mm
Strike Plate Size	38x15x1.45mm
Screw Size	M4
Magnet Coating	Zinc
Magnetic Force	Up to 10 lb.



Flat Door Magnet • 13lb

Part #	DM-FM-13
Material	1 pc block neodymium magnet/1 pc. steel case/1 pc. strike plate/4 pc. screws/2 pc. adhesive tape
Magnet Size	41.5x17x2.3mm
Strike Plate Size	38x15x1.45mm
Screw Size	M4
Magnet Coating	Zinc
Magnetic Force	Up to 13 lb.



Pocket Door Magnet • 20lb

Part #	DM-BLKPOCKETMAG-3/4
Description	Magnet casing/welded plate. 3/4" disc magnet inserted into the casing. Flat strike plate/2 screw holes.
Color	Black powder coated
Screw Size	M4
Magnet Coating	Zinc
Magnetic Force	Up to 20 lb.



Pocket Door Magnet • 20lb

Part #	DM-POCKETMAG-3/4
Description	Magnet casing/welded plate. 3/4" disc magnet inserted into the casing. Flat strike plate/2 screw holes.
Screw Size	M4
Magnet Coating	Zinc
Magnetic Force	Up to 20 lb.



Pocket Door Magnet • 12lb

Part #	DM-POCKETMAG-1/2
Description	Magnet casing/welded plate. 1/2" disc magnet inserted into the casing. Flat strike plate/2 screw holes.
Screw Size	M4
Magnet Coating	Zinc
Magnetic Force	Up to 12 lb.



Magnetic Door Stop • 12.5lb

Part #	DM-PCDRSTPMAG-B
Material	1 pc block neodymium magnet, 2 pc. iron/1 pc. plastic case/1 pc. strike plate
Magnetic Grade	N42
Magnet Coating	Black Powder Coated
Plastic Case Size	38.1-L x 17-W x 14-Hmm
Colors Available	Black
Orientation	Axial Magnet/Iron Pc./Strike plate
Magnetic Force	Up to 12.5 lb.



1/2" • NdFeB Ring Pot Magnet • 10lb

Part #	DM-AM-1/2
Description	2 pc. Disc neodymium magnets/2 pc. steel cases/2 pc. strike plate/4 pc. stainless steel screws
Magnet Size	D11x3mm
Packing	OPP Bag
Magnet Coating	Nickel
Orientation	Through 3mm Height
Magnetic Force	Up to 10 lb.



3/4" • NdFeB Ring Pot Magnet • 20lb

Part #	DM-AM-3/4
Description	1 pc. ring/countersunk neodymium magnet/1 pc. steel case/1 pc. strike plate/3 pc. stainless steel screws
Magnet Size	D18x3mm-D4.2/D9.4
Packing	OPP Bag
Magnet Grade	N45
Orientation	Through 3mm Height
Magnetic Force	Up to 20 lb.



1" • Angle Mount Magnet • 40lb

Part #	DM-AM-1
Description	1 pc. ring/countersunk neodymium magnet/1 pc. steel case/1 pc. strike plate/3 pc. stainless steel screws
Packing	OPP Bag
Magnet Grade	N45
Orientation	Through 3mm height
Magnetic Force	Up to 40 lb.



1" • Magnetic Cabinet Door Catch • 12lb

Part #	DM-FMDC-12-BLKB
Description	1 pc. Magnet Catch/1 pc. Steel Plate
Size	W-1.75", Attaching points 1.5"
Magnetic Force	Up to 12 lb.



1" • NdFeB Countersunk Pot Magnet • 40lb

Part #	DM-HDFM-2-BEP
Description	1 pc. iron case/1 pc. NdFeB magnet
Iron Case	D25.4xD5.6xH9mm/wall thickness 2mm/Black epoxy coating
Inserted Nd-FeB magnet	D18.6xD5.4x6.55mm/N42 grade/Black epoxy coating/axial orientation
Magnetic Force	Up to 40 lb.



1" • NdFeB Countersunk Pot Magnet • 40lb

Part #	DM-HDFM-2
Description	1 pc. iron case/1 pc. NdFeB magnet
Iron Case	D25.4xD5.6xH9mm/wall thickness 2mm/nickel coating
Inserted Nd-FeB magnet	D18.6xD5.4x6.55mm/N42 grade/nickel coating/axial orientation
Magnetic Force	Up to 40 lb.



1 1/2" • NdFeB Ring Pot Magnet • 110lb

Part #	DM-HDFM-1
Description	1 pc. iron case/1 pc. NdFeB magnet
Iron Case	D38.1xD5.6xH9.6mm/wall thickness 3mm/nickel coating
Inserted Nd-FeB magnet	D28xD10.3x6.55mm/N42 grade nickel coating/axial orientation
Magnetic Force	Up to 110 lb.



Heavy-Duty Truck Door Magnet • 60lb

Part #	DM-TRMAG-B-N DM-TRMAG-B-S
Description	1 pc. ABS plastic case/D58x34mm/1 pc. plastic covered neodymium pot magnet (N35 grade)/1 pc. 304 SS ball-headed adjustable screw w/ female thread (same width of hex head)/1 pc. 304 SS spring/1 pc. Polarity label
Magnetic Force	Up to 60 lb. per magnet



Magnetic Hook • 20lb

Part #	DM-HKMAG-BLK
Size	Dia. 20mm
Magnetic Coating	Nickel
Iron Case/ Hook Coating	Black powder coated
Magnetic Force	Up to 20 lb.



1/2" • Magnet Set • 12lb

Part #	DM-1/2LK-SET
Description	2 pc. N45 disc magnet (Dia. 12.7x3.2mm) 2 pc. contact washer/2 pc. cup washer/2 pc. screw
Screw Coating	Zinc
Magnetic Force	Up to 12 lb.

3/4" • Magnet Set • 20lb

Part #	DM-3/4LK
Description	2 pc. N45 disc magnet (Dia. 4.2x19mm) 2 pc. contact washer/2 pc. cup washer/2 pc. screw
Screw Coating	Zinc
Magnetic Force	Up to 20 lb.

Strike Plate

Part #	DM-STRIKEPLATE-BLK
Description	1.5 baggage door magnets
Color	Black powder coated

Strike Plate

Part #	DM-RNDSTKPLATE-BLK
Description	Round plate
Color	Black powder coated
Thickness	3mm



Disc Magnet • 9.2lb

Part #	DM-1/2X3/16 DISC
Size	.05x.1875"(Dia.x Height)
Grade	N45
Coating	Nickel/Copper (Ni-Cu-Ni)
Orientation	Axially
Material	Neodymium
Tolerance	+/- 0.004"
Max Operating Temp.	176 °F
Surface Field	4,665 Gauss
Magnetic Force	Up to 9.2 lb.

Disc Magnet • 10.8lb

Part #	DM-1/2LK
Size	.05x.25" (Dia. x Height)
Grade	N45
Coating	Nickel/Copper (Ni-Cu-Ni)
Orientation	Axially
Material	Neodymium
Tolerance	+/- 0.004"
Max Operating Temp.	176 °F
Surface Field	4,665 Gauss
Magnetic Force	Up to 10.8 lb.

Custom sizes, shapes, and strengths available

Warehouse | Safety

ObeCo material handling, warehouse pallet rack nets, forklift storage organizers, earth friendly green pallet wrap nets, and semi-tractor trailer pallet divider nets are just some of the products we create and custom make for warehouses, factory, industrial, and commercial applications.

Sliding Pallet Rack Safety Net

Keep warehouses safe with our removable and adjustable Pallet Rack Safety Nets. This safety net keeps things where they should be on the pallet rack. They're engineered to allow easy access while still keeping things safe on the rack.

Available Sizes: 8' • 9' • 10' • 11' • 12'



Heavy Duty Pallet Rack Netting

2000 lb. rated Heavy Duty Pallet Rack Netting. ObeCo's Safety and Commercial Custom Netting products are industrial workhorses. ObeCo meets or exceeds industry safety standards. Our Safety nets can help you comply to OSHA safety codes and regulation 1910.176(b). Storage of material shall not create a hazard. Bags, containers, bundles, etc., stored in tiers shall be stacked, blocked, interlocked and limited in height so that they are stable and secure against sliding or collapse.

Available Sizes: 8' • 9' • 10' • 11' • 12' • 14'



20" Tall • Storage Rack Safety Nets

These safety nets are ideal for ensuring everything stored on free standing adjustable shelves stay put while still being easily accessible. The patented "S" hooks are designed to easily connect the safety netting with most any design of shelving racks.. The hooks can be adjusted on the net ensuring a perfect fit.

Available Widths: 4' • 8' • 9' • 10' • 11' • 12'



Pallet Wrap Safety Net

Eliminate plastic shrink wrap forever! ObeCo's pallet wrap net replaces shrink wrap and is reusable, saving you money and the planet from plastic shrink wrap. Reusable pallet wraps cover the perimeter of the pallet and are adjustable to allow for large and small boxes to be secured .

- 36" x 180" with adjustable straps for tightening
- Designed for either 40"x48" or 48"x48" pallet



2000 lb. • Heavy Duty Semi Trailer Net

This safety net keeps cargo secure, in a truck trailer, engineered to allow for quick installation and removal. This product manufactured with E-clips and cam buckles.



Truck Dock Safety Mesh Barrier

This heavy-duty barrier is ideal for blocking access to a open or occupied truck dock. Four seat belt buckles at attaching points make installation and removal possible in seconds. (500 lb limit)



Magnetic Hopper Cover Net

Keep your facility clean and free of debris with our Magnetic Hopper Net. Made with rare earth neodymium magnets, our hopper net installs in seconds, and is easy to adjust.



E-Track Stretch Net Organizer

This Stretch Net Organizer is ideal for mounting directly to an installed E-track system common on walls in box trucks and semi-trailers. It is designed for securing items while in transit such as tie downs, wheel chocks, bungee cords, gloves, clip boards etc.



Forklift Organization

14" x 25" • Forklift Clear Pocket with Stretch Net

Clear Pocket w/Stretch Net, Adjustable Straps and Heavy Duty Magnets. Designed for clipboards, gloves, safety helmets, straps, paperwork, and service papers, keeping your items secure and organized.

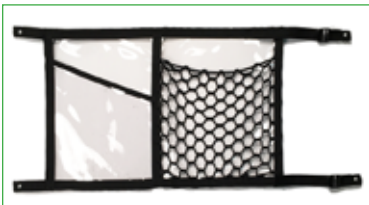

12" x 25" • Forklift Envelope Net

Storage Space for Forklifts and Tow-motors. This universal fitting Forklift Organizer attaches in seconds with magnets providing storage space for gloves, safety helmets, tools, clipboards, and jackets without obstructing your view.



Magnetic Mesh Phone Pocket

Magnetic black mesh pockets. Instantly stores cell phones, markers, note pads, garage door openers.

Available Sizes: 6" x 5" • 10" x 12"



Magnetic Paper Towel Holder

Sticks on any steel surface! Tool boxes, metal plates, metal doors, fork lifts, under hoods of cars, man caves, she sheds, laundry rooms, and more.



Upholstery Buttons | Caps

ObeCo has the capability to custom cover your upholstery buttons. Whether it's rich Corinthian Leather, Virgin vinyl, Vucana Sheep Wool, or Venezuelan Beaver fur, we've got your buttons covered. Call for more information.

Part No.

BT-30 • #30

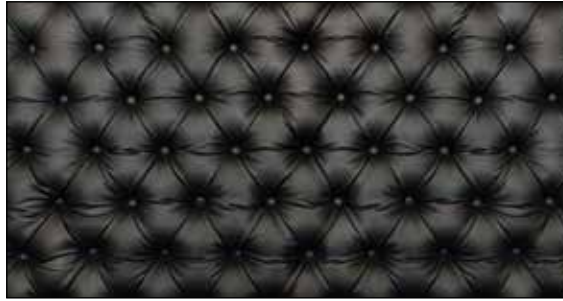

Fastener SNAP-CAPS | TAP-CAPS

SNAP-CAPS® screw covers are used to conceal many types of screws, bolts, nails and rivets. SNAP-CAPS® are comprised of a cap and washer. Your fastener fits securely into the plastic washer and the cap snaps over the washer to completely cover your fastener while providing an airtight seal that helps prevent rust and corrosion. SNAP-CAPS® Screw Covers are available in Size 8/8 and Size 12/12. Made from high-impact UV stabilized plastic and are suitable for indoor and outdoor use. SNAP-CAPS® are available in 64 stock colors.

Press TAP-CAPS® onto a countersunk Phillip or Pozidriv screw and like magic- the screw disappears. TAP-CAPS® press-on screw covers for your #8 "countersunk" screws with Phillips or Pozidriv recesses. Ideal for flat head ,drywall, wood, and bugle head screws. TAP-CAPS® Screw Covers are precision engineered with 16 holding splines to install easily yet grip securely. Made from high-impact UV stabilized plastic TAP-CAPS®. (suitable for indoor and outdoor use)



60+ Colors

TAP-CAPS® Special Order Colors available.

We're always thinking up new products you've never thought of...



Have ideas? We'll build it for you

Sure Seal®

SURE-SEAL® expands to seal between surfaces. Stops air, vapor, moisture, dust, sound and vibration. SURE-SEAL® provides you with a dry saturant and strong adhesive backing for installation. Seal Surfaces remain dry, dirt-free, and touchable. At 50% compression SURE-SEAL® provides a 100% seal against air and water.

A 10 Year Warranty and complete penetration of saturants prove you can't specify or buy a more advanced foam sealant tape. SURE-SEAL® possesses the sealing characteristics of closed cell foams, but not the compression set and compression restrictions of closed cell foams. SURE-SEAL® possesses the compression/recovery characteristics of a sponge, but will not absorb water more than 5% and will last more than twenty years.

SURE-SEAL® expands to seal between surfaces. Stops air, vapor, moisture, dust, sound and vibration. SURE-SEAL® provides you with a dry saturant and strong adhesive backing for installation. Seal surfaces remain dry, dirt-free and touchable. At a minimum of 50% compression SURE-SEAL® provides a 100% seal against air and water infiltration.

Use SURE-SEAL® to eliminate the messy caulking process in: Boats - RV's - Cargo Trailers - Aircraft - Plumbing/Heating/Cooling - Construction

SURE-SEAL® is an effective sealing solution ANYTIME you are permanently mating two parts together.

SURE-SEAL® is available in tapes and custom gaskets.

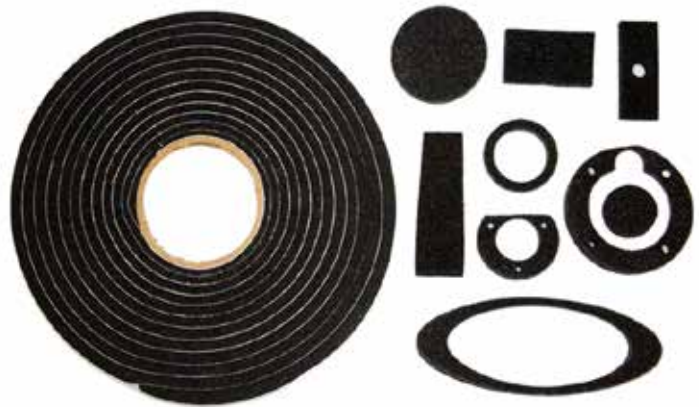

SURE-SEAL® Won't

- Need Replacing
- Wind-up on Screws
- Lose Saturant
- Bleed
- Leak out of Joint
- Fail to Adhere
- Dry out
- Crack
- Need trimming or Clean Up
- Fail to Seal
- Loosen from Vibration
- Permit Air Passage
- Be Damaged by Over-Compression



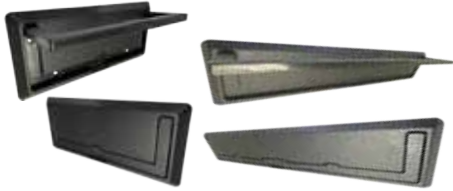

12" & 24" • Ceiling Mount Collapsing Hangers

Part #	12" • 90-7030-01 24" • 90-7010-01
Description	Ceiling mount clothing hanger (wall mounting optional)
Material	Polyacetal Plastic/UV resistant



12" • Ceiling Mount Slide Hanger

Part #	XF-130/300 ROD
Description	In-cabinet ceiling mount hanger
Material	Chrome Plated Nickel/Zinc



"Insta" Collapsible Wall Mount Hanger

Part #	AH12/M
Description	Wall mount clothing hanger
Material	Polyacetal Plastic/UV resistant



Collapsible Apparel Hanger • Thinline

Part #	TH-2102
Description	Wall mount clothing hanger
Material	Polyacetal Plastic/UV resistant

Telescopic

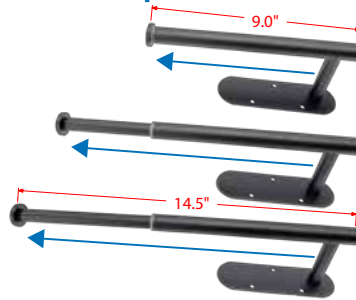

Towel-Bathroom Tissue-Garment-Holder • Wall Mount

Part #	ZJH-C02
Description	Wall mount clothing hanger
Material	Aluminum/Powder coated

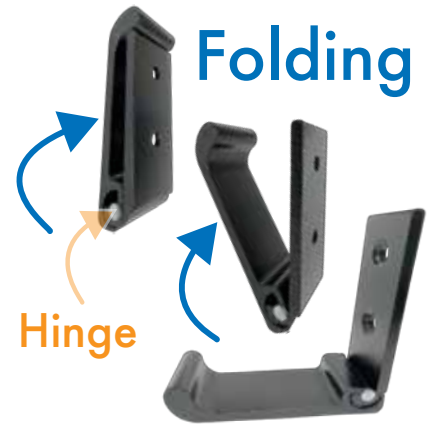

Folding Thinline Hook

Part #	ZDYG-01
Description	Wall mount clothing hanger
Material	Aluminum/Powder coated



Aluminum Peg Hook

Description	This 2" tall hook is made of solid aluminum and won't rust.
Color	Black/Silver
Material	Aluminum/Powder coated



Shower Caddy

Description	Corner mount shower shelf.
Material	Powder coated steel.



Shower Caddy

Description	Corner mount shower shelf.
Material	Powder coated Aluminum.

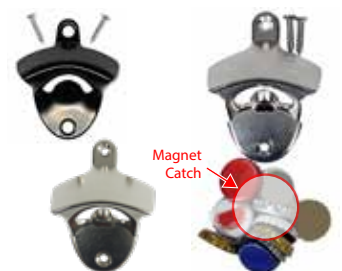

Bottle Openers

Description	Available in (4) variations.
Color	Black/Nickel
Material	Nickel plated/Black powder coated/Stainless steel

Heated Towel Rack



Heated Towel Rack

Part #	GDSS-504504
Description	This Obeco product is designed for drying or warming towels for indoor use.
Power	Hard Wired --120V AC / 80W Current draw 0.67A
Size	500MM x 450MM 19.68" x 17.71"
Material	Black Power Coated Aluminum

Quality Custom Industrial Sewing

- TIE-DOWN STRAPS
- RARE EARTH MAGNETS
- CARGO NETS
- ORGANIZERS | STORAGE POCKETS
- INDUSTRIAL TEXTILES
- WINDOW COVERS
- BUG SCREENS
- SAFETY BARRIERS

More Great Organization Products

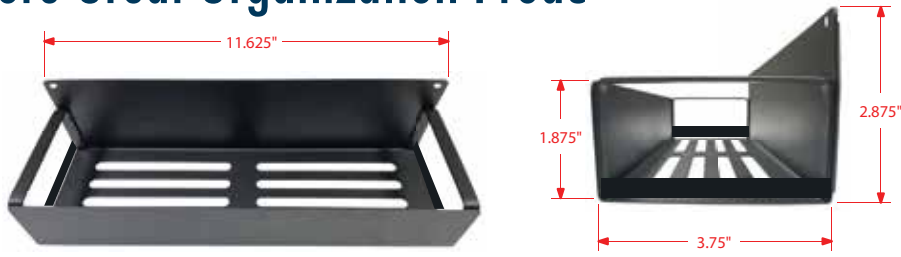

Magnetic Shelf • 8lb. Capacity	
Part #	ZJH-A-HSP002
Description	Obeco's® new magnetic backed storage shelf can be easily mounted to any flat ferrous metal surface. This organizer is perfect for mounting to the side of a refrigerator, tool chest, cabinet, etc.
Material	Metal, Powder Coated Black Finish

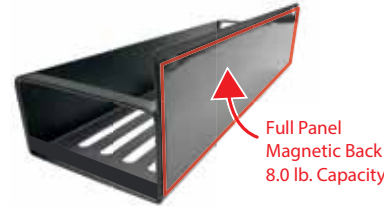

1" Furniture Slides	
Part #	HWY-T25
Description	Pressure sensitive slide for furniture legs
Color	Lite Gray/Black
Material	Nylon



Utility Snap-In Holder	
Part #	ZJH-BGC
Description	This utility hanger is ideal for storing any tool with a handle have a diameter from .75" to 1". Powder coated springsteel ensures both durability and longevity.
Material	Metal, Powder Coated Black Finish

Utility Snap-In Holder & Hook	
Part #	ZJH-BGCH
Description	This utility hanger is ideal for storing any tool with a handle have a diameter from .75" to 1". Powder coated springsteel ensures both durability and longevity.
Material	Metal, Powder Coated Black Finish

Heavy-Duty • Utility-Hanger	
Part #	ZJH-GS012
Description	Heavy-Duty Utility Hanger has a generous 2.25" opening, designed to meet the demands of your organizational needs with unmatched durability and versatility.
Material	Metal, Powder Coated Black Finish

Heavy-Duty • Utility-Hanger	
Part #	HWY-T25
Description	Heavy-Duty Utility Hanger has a generous 4.625" opening, designed to meet the demands of your organizational needs with unmatched durability and versatility.
Material	Metal, Powder Coated Black Finish



Bunk Bed Safety Net	
Description	Detachable bunk bed barrier.
Material	Webbing, textilene, 2" belt buckles, mounting hardware

Pet Bowl Essentials Kit	
Description	Kit contains: (2) bowls, (1) pet leash, (1) 8" x 11" Plastic framed pock net
Material	Pet bowls • Stainless steel Leash • Nylon Framed net • Stretch net/ plastic frame

EZ Charge Battery Charging Units	
Part #	EZCB
Description	"Easy" access to battery connections for jumping or charging, in both automotive and marine applications.
Material	Polyacetal Plastic/UV resistant

ObeCo TV Mounts

TV Mounts for moving vehicles.
Locking mounts made of rust resistant strong cast aluminium

404L Full Motion Articulating Locking Mount
 VESA: 50x50, 75x75, 100x100, 150x150, 200x200, 300x300
 Weight Capacity: 25 lbs
 Arm Extension: 25"
 Profile: 2.7"
 Price: \$55.00 ea. (10 per case)

408L Full Motion Articulating Locking Mount
 VESA: 50x50, 75x75, 100x100, 150x150, 200x200, 300x300
 Weight Capacity: 55 lbs
 Arm Extension: 16.5"
 Profile: 2.7"
 Price: \$59.00 ea. (10 per case)

403L Full Motion Articulating Locking Mount
 VESA: 50x50, 75x75, 100x100
 Weight Capacity: 23 lbs
 Arm Extension: 18.5"
 Profile: 2.7"
 Price: \$40.00 ea. (10 per case)

554E Ultra-Slim Flat TV Universal Mount
 VESA: 200x200-400x400
 Weight Capacity: 145 lbs
 Tilt: Down 10 degrees
 Ultra Slim Profile: 1.6"
 Price: \$33.00 ea. (5 per case)

2311L-2 Full Motion Articulating Locking Mount
 VESA: 75x75, 100x100
 Weight Capacity: 23 lbs
 Arm Extension: 14.5"
 Tilt: Up 8 Degrees, Down 12 degrees
 Profile: 2.75"
 Price: \$49.00 ea. (10 per case)

301 Under Cabinet Mount
 VESA: 75x75, 100x100
 Weight Capacity: 25 lbs
 Profile: 1" Tol
 Price: \$28.50 ea. (12 per case)

101 Flat Fixed Mount 2 Plate Design
 VESA: 50x50, 75x75, 100x100
 Weight Capacity: 75 lbs
 Profile: .75"
 Price: \$8.75 ea. (24 per case)

401 Full Motion Articulating Heavy Duty Mount
 VESA: 75x75, 100x100, 200x200, 300x300
 Weight Capacity: 55 lbs
 Arm Extension: 14.5" (Horizontal Mount)
 Profile: 1.5"
 Price: \$34.00 ea. (5 per case)

422F-L Multi-Location Travel Mount
 VESA: 75x75, 100x100, 200x200, 300x300
 Weight Capacity: 18 lbs
 Includes: LCD Plate and 2 brackets
 Price: \$28.00 ea. (10 per case)

2521 Industrial Parkway, Elkhart, IN 46516 574-266-1809 www.ObeCoInc.com

ObeCo WE'VE GOT YOU COVERED IN STOCK NOW

2024 • NEW PRODUCTS

1" • Furniture Slide • Self-Adhesive PN • HWY-T25

Protect your flooring using our new ObeCo® self-adhesive Furniture Slides. These 1in. peel & stick pads, made of PTFE, are easy to install and prevent floor damage.



1" • Magnetic Cabinet Door Catch PN • DM-FMDC-12-BLK

ObeCo's® new Magnetic Door Catch is manufactured with ferrite magnets rated for up to 12 lb. and is engineered to replace inferior bulldog catches.



ObeCo WE'VE GOT YOU COVERED AVAILABLE FOR IMPORT APPROX 75 DAYS

2024 • NEW PRODUCTS

In-Cabinet 2-Shelf Organizer

An ideal in-cabinet storage organizer for maximizing space and allowing for easy access to your items. This sturdy, lite weight and easy to assemble unit includes a slide out lower shelf.



In-Cabinet Under Sink Off-Set 2 Shelf Organizer

This in-cabinet storage organizer is designed to make the most of available space under a sink where plumbing means standard shelving units won't fit. This sturdy, lite weight and easy to assemble unit includes a slide out lower shelf.



ObeCo WE'VE GOT YOU COVERED IN STOCK NOW

2024 • NEW PRODUCTS

Magnetic Shelf • 8lb. Capacity

ObeCo's® new magnetic backed storage shelf can be easily mounted to any flat ferrous metal surface. This organizer is perfect for mounting to the side of a refrigerator, tool chest, cabinet, etc.



Ceiling Mount Sliding Towel Rack PN • XF-130/300 ROD

This ceiling mount in-cabinet towel rack keeps linens organized and easily accessible. This sliding rack has 8.5 inches of travel when extended.

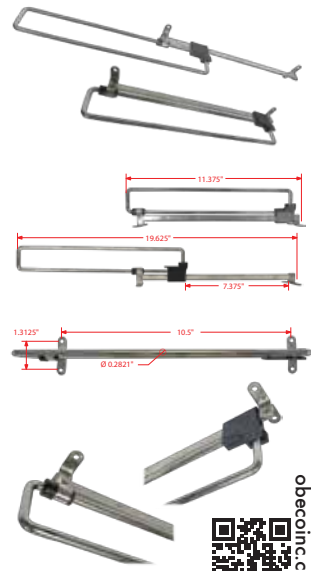

2521 Industrial Parkway Elkhart, IN 46516 | Phone • (574) 266-1809

P.O. Submission • orders@obe.coinc.com

2521 Industrial Parkway Elkhart, IN 46516 | Phone • (574) 266-1809

P.O. Submission • orders@obe.coinc.com

SERVICES

- Design | Development
- Prototyping
- Short | Long run production
- Industrial sewing
- Strap cutting
- Fabric welding
- CNC textile cutting services

2521 Industrial Parkway Elkhart, IN 46516

Phone • (574) 266-1809

P.O. Submission • orders@obecoinc.com

obecoinc.com

ObeCo Inc. has been manufacturing OEM sewn goods for RV, Marine, Heavy Truck, Emergency Vehicles, Golf Carts, Cargo Trailer, and Warehouse industries since 1990. We engineer unique organizational and safety products featuring custom sewn cargo netting, screens, and straps, in infinite variations.

ObeCo Incorporated, a Christian owned and operated company.

